



PRODUCT DATA SHEET

Laser Diode (HHL w/window package)

Model FB-M1060-3000HO

Specification	Symbol	Typical	Unit
Laser Emitter			
Peak Wavelength	λ_{op}	1060±20	nm
CW Optical Output Power	P_{op}	3	W
Operation Current	I_{op}	<4	A
Operation Voltage	U_{ld}	1.5±0.2	V
Threshold Current	I_{th}	< 0.6	A
Beam Divergence (FWHM)	$\theta_{ }$	8±2	degree
Beam Divergence (FWHM)	θ_{\perp}	1	degree
Spectrum Half-Width (FWHM)	$\Delta\lambda$	< 3.5	nm
Emitting Area	$W \times d$	100x1	$\mu m \times \mu m$
Operation Mode	-	CW, QCW, Pulse ($\tau > 5ns$)	-
Operation Temperature	Top	25	degree
Photo Diode Monitor			
PD Monitor Current		1-1000	μA
PD Reverse Voltage		9	V
TEC			
Maximum Current		5	A
Maximum Operation Voltage		3,8	V
Thermistor			
Resistance		10	kilohm
Wavelength Temperature Coefficient	$\Delta\lambda/\Delta T$	3±0.2	Å/degree
Operation Current Temperature Coefficient	$\Delta I/\Delta T$	15±5	mA/degree
Operation Temperature Range		-20... +40	degree
Storage Temperature Range		-40... +80	degree



Output window on the top of HHL (optional)

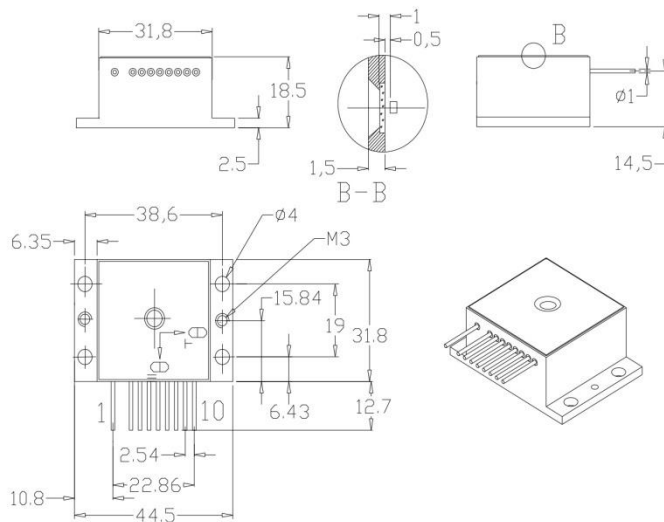

- 1-TEC (-)
- 2-
- 3-
- 4- Laser Anode(+)
- 5- Thermistor (2)
- 6- Thermistor (1)
- 7- Laser Cathode (-)
- 8- PD Anode (+)
- 9- PD Cathode (-)
- 10- TEC (+)

Output window of 0.5 mm in thickness

Output window on the front side of HHL (by default)

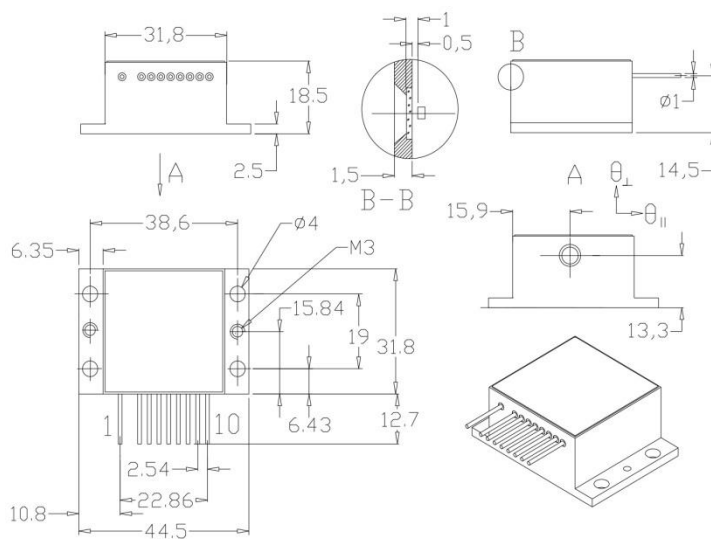

- 1- TEC (-)
- 2-
- 3-
- 4- Laser Anode(+)
- 5- Thermistor (2)
- 6- Thermistor (1)
- 7- Laser Cathode (-)
- 8- PD Anode (+)
- 9- PD Cathode (-)
- 10- TEC (+)

Output window of 0.5 mm in thickness